





Sumário

Suportes para Torneamento Grand Turn	3
Torneamento Externo	4
Torneamento Interno.....	13
Suportes para Rosquear.....	19
Bedames.....	20
Ferramentas para Furação Grand Drill.....	22
Cápsulas para Mandrilar	23
Brocas.....	27
Suportes para Fresamento Grand Mill.....	28
Cabeçotes de Fresar 90°	29
Cabeçotes de Fresar 75°.....	31
Cabeçotes de Fresar 45°.....	33
Fresas Topo.....	35
Fresas Abacaxi.....	44
Fresas de Disco.....	55
Outros Modelos de Fresas.....	58

Suportes para torneamento *Grand Turn*





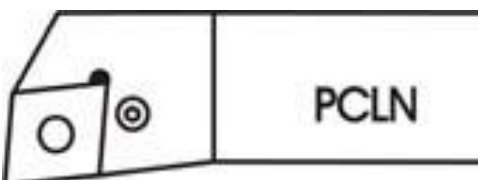

Torneamento Externo

Referências ISO		Componentes				
		Parafusos 	Alavancas 	Calços 	Rebites 	Pastilhas 
PCBNR/L	2020K12	174.3-821	174.3-841M	171.31-850M	174.3-861	CNMM
	2525M12					CNMG
PCKNR/L	3225P12					174.3-822
	3232P12	CNMA				
PCLNR/L	4040S19					
	5050W19					





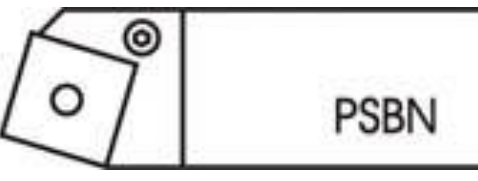

PCLN





Referências ISO		Componentes				
		Parafusos 	Alavancas 	Calços 	Rebites 	Pastilhas 
PSBNR/L	2020K12	174.3-821	174.3-841M	171.31-850M	174.3-861	SNMM
	2525M12					SNMG
PSDNR/L	3225P12					174.3-822
	3232P12	SNMA				
PSSNR/L	4040S19					
	5050W19	174.3-827	174.3-844M	174.3-853M	174.3-865	



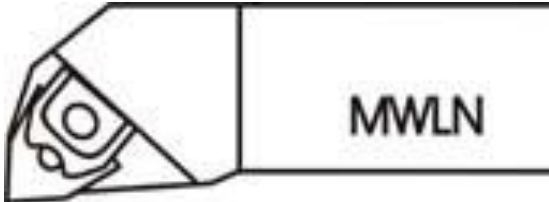



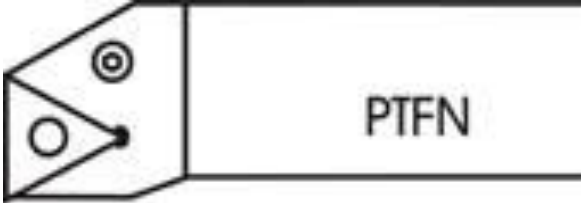

PSBN

Referências ISO		Componentes			
		Cunhas 	Pinos 	Calços 	Pastilhas 
MWLNR/L	2020K06	5431125-011	531302201	5322331-06	WNMG0604
	2525M06				
	3225P06				
	4032P06				
	2020K08	5431125021	532233107	5322331-07	WNMG0804
	2525M08				
	3225P08				
	4032P08				







Referências ISO		Componentes				
		Parafusos 	Alavancas 	Calços 	Rebites 	Pastilhas 
PTFNR/L	1616H16	174.3-820	174.3-840M	179.3-850	174.3-860	TNMM
	2020K16					TNMG
	2525M16					
PTGNR/L	3225P16	174.3-821	174.3-821M	179.3-852	174.3-861	TNGA
	3232P22					TNMA
	4040S27					174.3-825

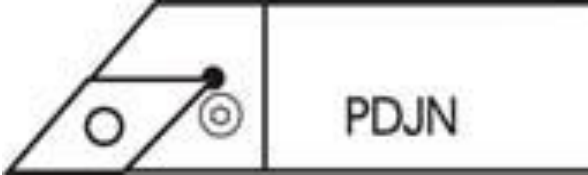

Referências ISO		Componentes				
		Parafusos 	Alavancas 	Calços 	Rebites 	Pastilhas 
PDJNR/L	1616H15	174.3-830	174.3-847M	171.35-850	174.3-861	DNMG
	2020K15					DNGA
2525M15	DNMA					
PDNNR/L	3225P15					DNVM
	4025P15					
	5032S15					







PDJN





Referências ISO		Componentes				
		Parafusos 	Alavancas 	Calços 	Rebites 	Pastilhas 
PRDCNR/L	2020K09	174.3-820	174.3-840	176.3-850	174.3-863	RCMX
	2525M12					RCMT
	3225P12					
	3232P19					
	4040S19	174.3-821	174.3-841	176.3-861M	174.3-861	RNMG
	5050T19	174.3-822	174.3-842	176.3-852M	174.3-862	RNGA







PRDCN

Referências ISO		Componentes				
		Parafusos 	Cunhas 	Calços 	Pinos 	Pastilhas 
MTFNR/L	2020K16	5512.031-01	170.38-820	70.3-852	5313.021-02	TNMM
	2525M16					TNMG
MTNNR/L	3232P16	5512.031-02	170.38-821	170.38-821	5313.021-03	TNGA
MTJNR/L	3232P22					TPGN
		4040S22				

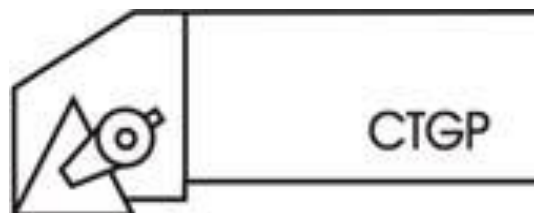





Referências ISO		Componentes			
		Grampos 	Calços 	Parafusos 	Pastilhas 
CTGPR/L	1212H11	174.9-830-2	-	-	TPMR
	1616J11				TPGR
CTFPR/L	2020K16	174.9-832-2	17511621	PAAM4	TPUN
	2525M16				TPGN
	3225P16				
	3232P22				
	4040S22	174.9-838-2	17511624		
	5050W32				

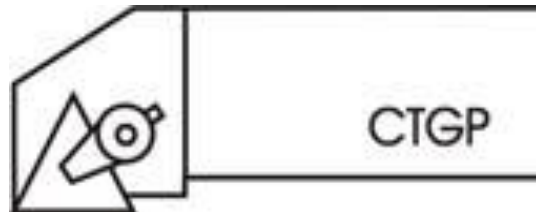





Referências ISO		Componentes				
		Grampos 	Calços 	Parafusos 	Pastilhas 	
CSKPR/L	1212H09	174.9-830-2	-	-	TPMR	
	1616J09					
CSRPR/L	2020K12	174.9-832-2	175.2-850	PAAM4	TPGR	
	2525M12				TPUN	
CSSPR/L	3225P12					
	3232P19					
	4040S19	174.9-838-2	175.2-851		TPGN	
	5050W33					

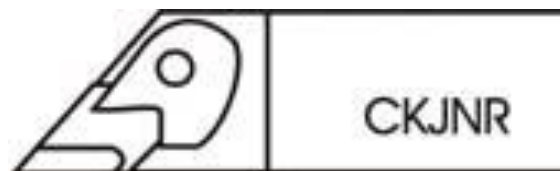





Referências ISO		Componentes			
		Grampos 	Calços 	Rebites 	Pastilhas 
CKJNR	2525M16	170.5-824	R170.5-851	174.1-865	KNMX
	3225P16				KNUX
	4025S16				
	5032T16				

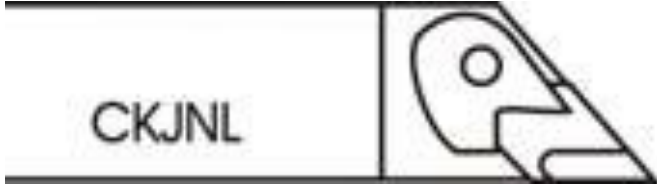





Referências ISO		Componentes			
		Grampos 	Calços 	Rebites 	Pastilhas 
CKJNL	2525M16	170.5-824	L170.5-851	174.1-865	KNMX KNUX
	3225P16				
	4025S16				
	5032T16				

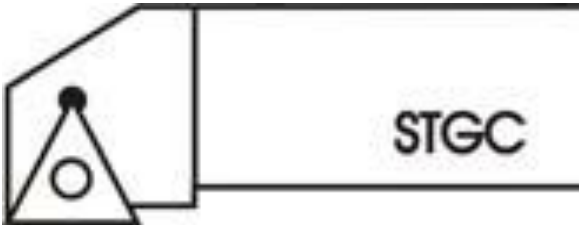





Referências ISO		Componentes			
		Parafusos 	Calços 	Paraf. Dos Calços 	Pastilhas 
STGCR/L	0808D09	5513020-05	-	-	TCGT
	1010E09				
STTCR/L	1212H11	5513020-03	-	-	TCGX
	1616J11				
STFCR/L	2020K16	5513020-01	5322322-11	5512090-01	TCMT TCMW
STDCR/L	2525L16				
STBCR/L					

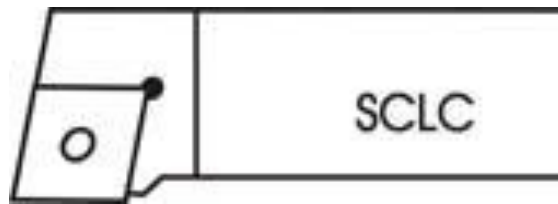





Referências ISO		Componentes			
		Parafusos 	Calços 	Paraf. Dos Calços 	Pastilhas 
SCLCR/L	0808D06	5513020-03	-	-	CCGT
	1010E06				
SCBCR/L	1212H09	5513020-10	5322322-11	5512090-01	CCGX
	1616J09	5513020-01			
SCKCR/L	2020K12	5513020-18	5322232-02	5512090-03	CCMT
	2525L12				CCMW

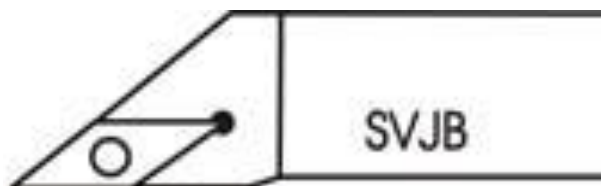





Referências ISO		Componentes			
		Parafusos 	Calços 	Paraf. Dos Calços 	Pastilhas 
SVJBR/L	1616J16	5513020-01	5322270-01	5512090-01	VBGT
	2020K16				
	2525L16				
SVQBR/L					VBMT
SWBN	3225P16				VCGX
					VBMW



Referências ISO		Componentes			
		Parafusos 	Calços 	Paraf. Dos Calços 	Pastilhas 
SDJCR/L	1212H11	5513020-03			DCGT
	1616J11	5513020-01			
	2020K12				
SDNCN	2525L11	5322270-01	5512090-01	DCGX	
				DCMT	
				DCMW	





SDJC

Referências ISO		Componentes			
		Parafusos 	Calços 	Paraf. Dos Calços 	Pastilhas 
SSRCR/L	1212H09	5513020-03			SCMT
	1616J09	5513020-01			
	2020K12				
SSSCN		5322420-01	5512090-01	SCMW	
SSKCR/L	2525L12				







SSRC





Referências ISO		Componentes	
		Parafusos 	Pastilhas 
SRGCR/L	1010E05	5513020-05	RCGX
	1212H06	5513020-03	
SRCCN	1616J06	5513020-04	RCMT



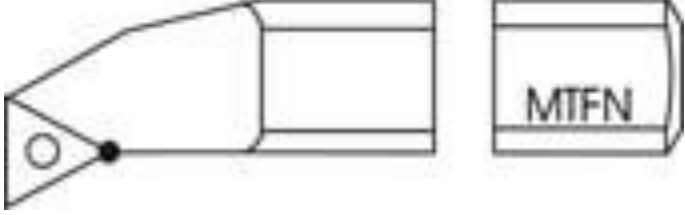



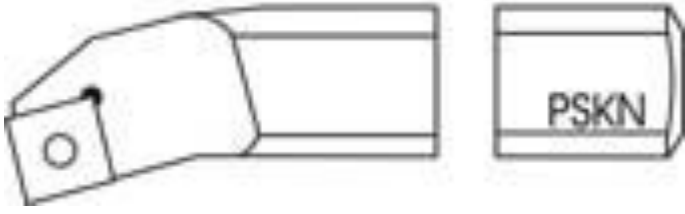

Torneamento interno

Referências ISO	Componentes				
	Parafusos 	Cunhas 	Calços 	Pinos 	Pastilhas 
S25T-MTFNR/L16W	5512031-01	170.38-820-1	-	5513.021-01	TNMM TNMG TNGA TNMA
S32U-MTFNR/L16W			170.3-852	5513021-02	
S40V-MTFNR/L22W	5512031-02	170.38-821-1	170.3-855	5513021-03	
S50W-MTFNR/L22W					







Referências ISO	Componentes				
	Parafusos 	Alavancas 	Calços 	Rebites 	Pastilhas 
S20S-PSKNR/L12	438.3-832M	438.3-841-1	-	-	SNMM SNMG SNGA SNMA
S25T-PSKNR/L12			-	-	
S32U-PSKNR/L12	174.3-858	174.3-848M	171.31-850M	174.3-861	
S40V-PSKNR/L12	174.3-821	174.3-841M	171.31-851M	174.3-868	
S50W-PSKNR/L16	174.3-822M	174.3-849M			

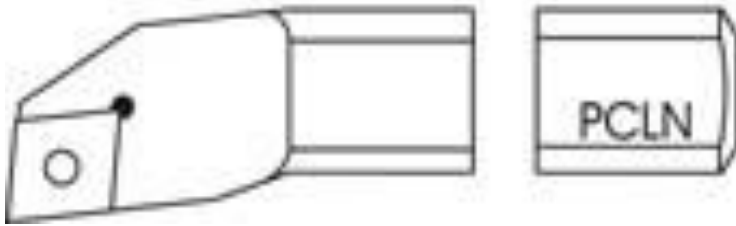

Referências ISO	Componentes				
	Parafusos 	Alavancas 	Calços 	Rebites 	Pastilhas 
S20S-PCKNR/L12	438.3-832M	438.3-841-1	-	-	CNMM CNMG CNGA CNMA
S25T-PCKNR/L12			-	-	
S32U-PCKNR/L12	174.3-858	174.3-848M	171.31-850M	174.3-861	
S40V-PCKNR/L12	174.3-821	174.3-841M	171.31-851M	174.3-868	
S50W-PCKNR/L16	174.3-822M	174.3-849M			





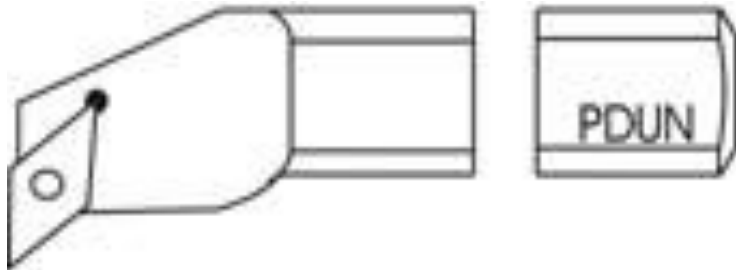

Referências ISO	Componentes				
	Parafusos 	Alavancas 	Calços 	Rebites 	Pastilhas 
S32U-PDUNR/L15	174.3-830	174.3-847M	171.35-850M	174.3-861	DNMG DNMA DNGA CNMM
S40V-PDUNR/L15					
S50W-PDUNR/L15					

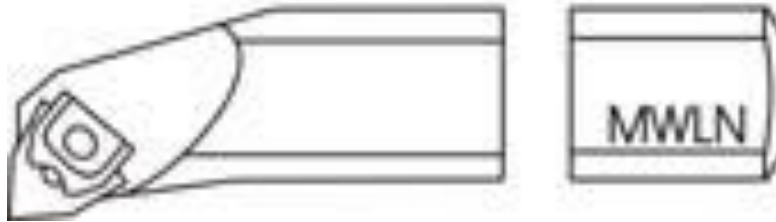





Referências ISO	Componentes			
	Cunhas 	Calços 	Pinos 	Pastilhas 
S20S-MWLNR/L06	5431125-011	-	531302201	5322.331-06
S25T-MWLNR/L06		-		
S32U-MWLNR/L06		531302201		
S40V-MWLNR/L06				
S50W-MWLNR/L06				
S25T-MWLNR/L08	5431125021	532233107	532233107	5322.331-07
S32U-MWLNR/L08				
S40V-MWLNR/L08				
S50W-MWLNR/L08				

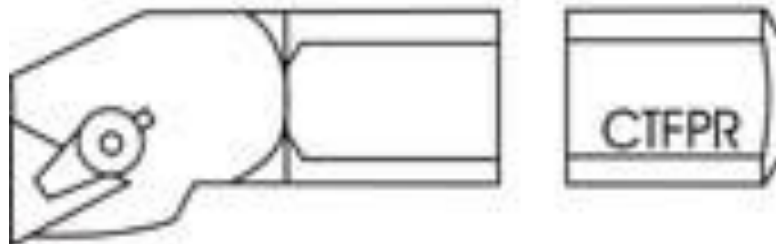





Referências ISO	Componentes			
	Parafusos 	Calços 	Grampos 	Pastilhas 
S12Q-CTFPR/L11	-	-	172.9-826	TPMR TPGR TPUN TPGN
S16R-CTFPR/L11			172.9-830-1	
S20S-CTFPR/L16				
S25T-CTFPR/L16			172.9-832-1	
S32U-CTFPR/L16				
S40V-CTFPR/L22	PAAM4	175.2-851	174.9-838	

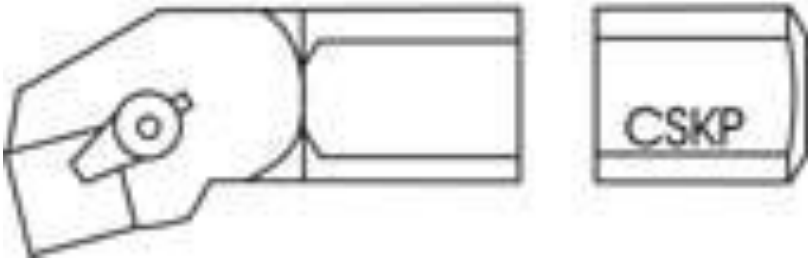





Referências ISO	Componentes			
	Parafusos 	Calços 	Grampos 	Pastilhas 
S12Q-CSFPR/L09	-	-	172.9-826	SPMR SPGR SPUN SPGN
S16R-CSFPR/L09			172.9-830-1	
S20S-CSFPR/L09			172.9-832-1	
S25T-CSFPR/L12				
S32U-CSFPR/L12				
S40V-CSFPR/L12			PAAM4	

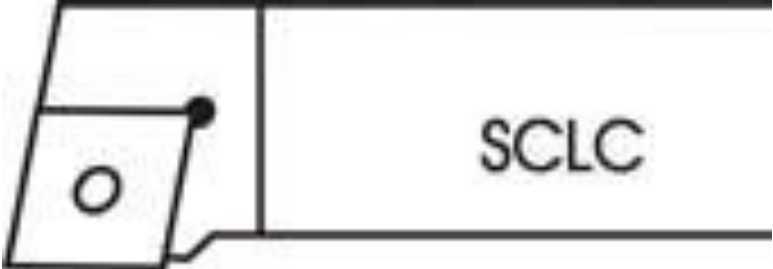





Referências ISO	Componentes			
	Parafusos 	Calços 	Paraf. Dos calços 	Pastilhas 
S12M-SCLCR/L06	5513020-03	-	-	CCGT CCGX CCMT CCMW
S16R-SCLCR/L09	5513020-09			
S20S-SCLCR/L09	5513020-17			
S25T-SCLCR/L12				
S32U-SCLCR/L12				
S40V-SCLCR/L12	5513020-18			

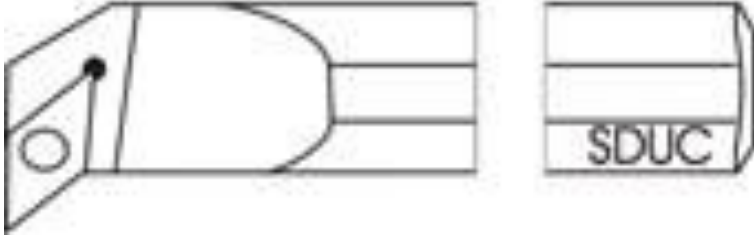



Referências ISO	Componentes			
	Parafusos 	Calços 	Paraf. Dos calços 	Pastilhas 
S16R-SDUCR/L11	5513020-03	-	-	CCGT CCGX CCMT CCMW
S20S-SDUCR/L11				
S25T-SDUCR/L11				
S32U-SDUCR/L11	5513020-01	5322263-01	5512090-01	

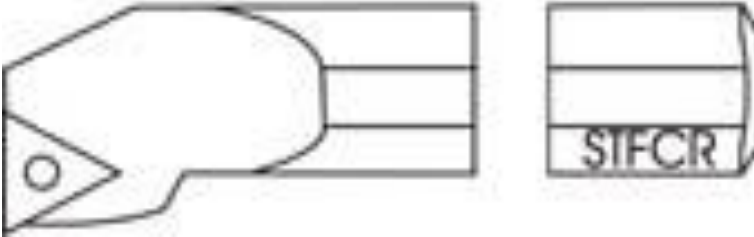

Referências ISO	Componentes					
	Parafusos 	Calços 	Paraf. Dos calços 	Pastilhas 		
S10K-STFCR/L09	5513020-05	-	-	TCGT		
S12M-STFCR/L09						
S16R-STFCR/L11	5513020-03			-	-	TCGX
S20S-STFCR/L11						
S25T-STFCR/L16						
S32U-STFCR/L16	5513020-01					5322320-01
S40V-STFCR/L16						



LINHA DE PRODUTOS

Referências ISO	Componentes	
	Parafusos	Pastilhas
		
S12M-SSKCR/L09	5513020-09	SCMT SCMW SCGX SCGT
S16R-SSKCR/L09		
S20S-SSKCR/L09	5513020-17	
S25T-SSKCR/L09		

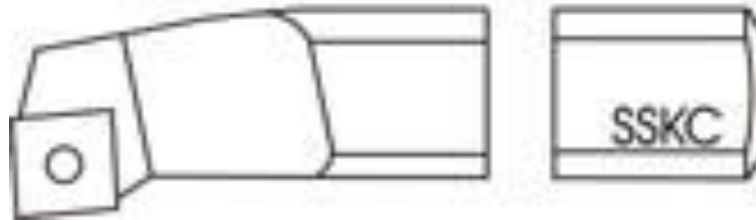

Suportes para Rosquear

Suportes para ferramentas externas

Referências	Tipo de inserto	h (mm)	b (mm)	f (mm)	L (mm)
STXNR 1616-H16	ER16	16	16	16	100
STXNR 2020-K16	ER16	20	20	20	125
STXNR 2525-M16	ER16	25	25	25	150

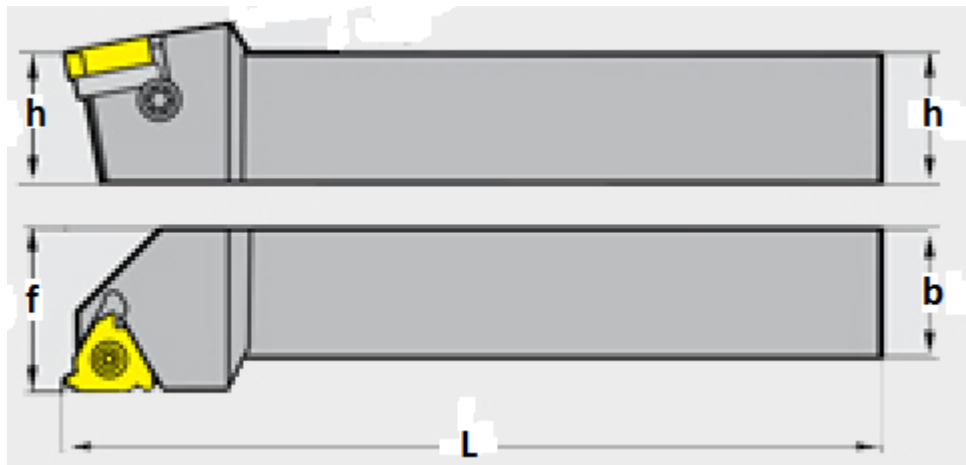

Suportes para ferramentas internas

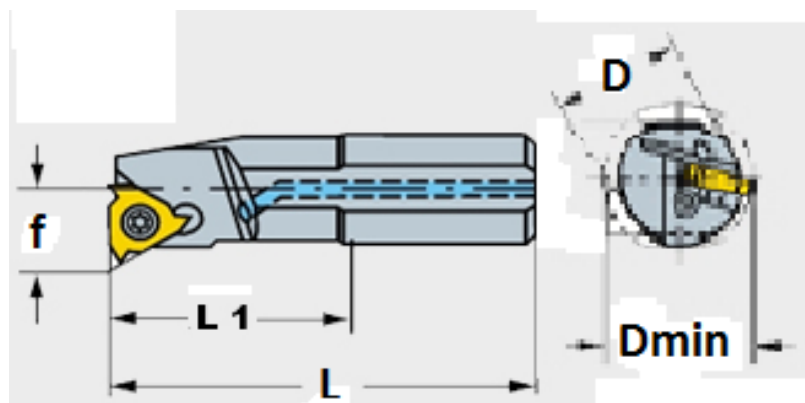

Referências	Tipo de inserto	D (mm)	D1 (mm)	Dmin (mm)	L (mm)	L1 (mm)	F (mm)
S10H-STXNR-11	IR11	10	10	12,5	100	-	7,3
S16K-STXNR-11	IR11	16	10	12,5	125	25	7,3
S16M-STXNR-16	IR16	16	13	16,5	150	32	10,4
S16P-STXNR-16	IR16	20	16	19,5	170	40	11,6
S16P-STXNR-16	IR16	20	20	23,5	170	-	13,6
S16R-STXNR-16	IR16	25	25	28,5	200	-	16,3

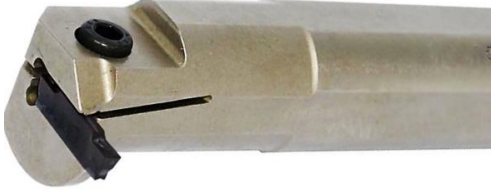

Bedames

Externo	Interno
	
Dimensões (mm)	
10 X 10	Ø 12
12 X 12	Ø 16
16 X 16	Ø 20
20 X 20	Ø 25
25 X 25	Ø 32
32 X 32	Ø 40
40 X 40	Ø 50





Frontal	Serras
	
Dimensões (mm)	
20 X 20	Ø 80
25 X 25	Ø 100
32 X 32	Ø 125
40 X 40	Ø 160
-	Ø 200

Lâmina	Suporte de lâmina
	
Dimensões (mm)	
	BL 25-32
-	BL 25-26





Ferramentas para Furação com Pastilhas
Intercambiáveis *Grand Drill*



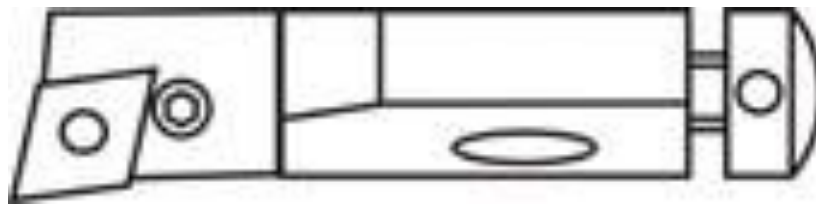



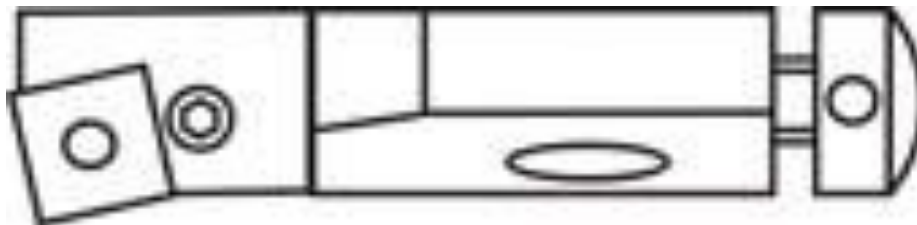

Cápsulas para mandrilar

Referências ISO	Componentes				
	Parafusos 	Alavancas 	Calços 	Rebites 	Pastilhas 
PCLNR/L 16CA12	174.3-858	-	171.31-850M	-	CNMM
PCFNR/L 16CA12	174.3-858	174.3-848M	-	171.31-850M	CNMG
PCGNR/L 25CA19	174.3-835	174.3-849M	171.31-851M	171.31-851M	CNMA







Referências ISO	Componentes				
	Parafusos 	Alavancas 	Calços 	Rebites 	Pastilhas 
PSKNR/L 12CA-12	438.3-832M	438.3-841M	-	-	SNMA
PSKNR/L16CA-12	174.3-858	174.3-848M	174.3-851M	174.3-861	SNMA
PSKNR/L 20CA-16	438.3-831	438.3-840	174.3-857	174.3-864	SNMG
PSKNR/L 25CA-19	174.3-835	174.3-849M	174.3-852M	174.3-868	SNMM







Referências ISO	Componentes				
	Parafusos 	Alavancas 	Calços 	Rebites 	Pastilhas 
PTFNR/L12CA-16	-	-	-	-	TNMM
PTGNR/L16CA-16	-	-	-	-	TNMG
PTTNR/L20CA-22	438.3-830	5432.015-011	-	-	TNGA
PTWNR/L12CA-16	174.3-820M	174.3-840M	179.3-850M	174.3-860	TNMA
PTSNR/L12CA-16	174.3-821	174.3-821	179.3-852M	174.3-861	TNMA

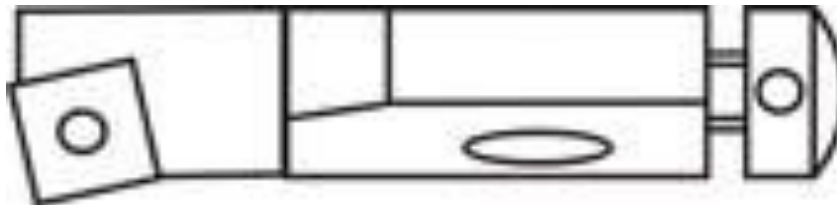





Referências ISO	Componentes			
	Parafusos 	Calços 	Parafusos dos Calços 	Pastilhas 
SSKCR/L10CA-09	5513 020-09	-	-	SCMT
SSKCR/L12CA-12	5513 020-17	-	-	SCMT
SSSCLR12CA-12	5513 020-18	5322 420-02	5512 090-03	SCMW







Referências ISO	Componentes			
	Parafusos 	Calços 	Parafusos dos Calços 	Pastilhas 
STFCR/L06CA-06	5513 020-27	-	-	TCGT
STGCR/L08CA-09	5513 020-05	-	-	TCGT
STSCR/L10CA-11	5513 020-03	-	-	TCGX
STTCR/L12CA-16	5513 020-10	-	-	TCMT
STWCR/L16CA-16	5513 020-01	5322 320-01	5512 090-01	TCMW

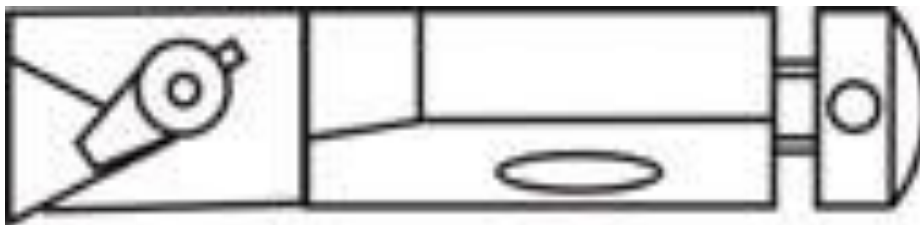

Referências ISO	Componentes			
	Grampos 	Calços 	Parafusos 	Pastilhas 
CTFPR/L10CA-11	-	-	-	TPMR
CTGPR/L10CA-11	-	-	-	TPMR
CTSPR/L12CA-16	172.9-826.1	-	-	TPGR
CTTPR/L16CA-16	172.9-827.1	-	-	TPUN
CTWPR/L16CA-16	172.9-827.1	175.2-850	PAAM4	TPGN



Referências ISO	Componentes			
	Grampos 	Calços 	Parafusos 	Pastilhas 
CSKPR/L10CA-09	172.9-826.1	-	-	SPGR
CSSPR/L12CA-12	172.9-827.1	-	-	SPGR
CSTPR/L16CA-12	172.9-827.1	175.2-850	PAAM4	SPGN

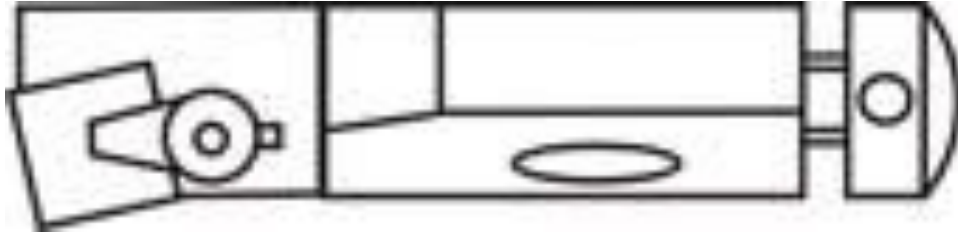

Brocas

Brocas para Pastilhas e com Refrigeração Interna	
Medidas (mm)	
Diâmetros (∅)	Comprimentos
12,7 a 17,0	
17,5 a 20,0	
21,0 a 35,0	
36,0 a 45,0	
46,0 a 60,0	
*Fabricamos também brocas especiais sob medida	

Suportes para Fresamento *Grand Mill*



Cabeçotes de Fresar 90º



Diâmetros de corte (mm)	Referências ISO	Pastilhas
040	040A03R-C90TP16C	TPKN 1603
050	050A03R-C90TP16C	
063	063A03R-C90TP16C	
080	080A04R-C90TP16C	
100	100B05R-C90TP16C	TPKN 2204
125	125B06R-C90TP16C	
160	160C07R-C90TP16C	
200	200C08R-C90TP16C	



Diâmetros de corte (mm)	Referências ISO	Pastilhas
080	080A05R-F90TP16C	TPKN 1603
100	100B07R-F90TP16C	
125	125B08R F90TP16C	
160	160C10R F90TP16C	
200	200C12R F90TP16C	TPKN 2204
250	250C16R F90TP16C	
315	315C20R F90TP16C	
400	400C26R F90TP16C	
500	500C34R F90TP16C	



Diâmetros de corte (mm)	Referências ISO	Pastilhas
040	040A03R-S90AP16C	APKT 1604
050	050A04R-S90AP16C	
063	063A04R-S90AP16C	
080	080A06R-S90AP16C	
100	100B06R-S90AP16C	APFT 1604
125	125B06R-S90AP16C	



Diâmetros de corte	Referências ISO	Pastilhas
050	050A04R-S90SE12P	SPMT 12T308
063	063A05R-S90SE12P	
080	080A06R-S90SE12P	
100	100B06R-S90SE12P	
125	125B08R-S90SE12P	
160	160C10R-S90SE12P	
200	200C12R-S90SE12P	
250	250C16R-S90SE12P	
315	315C20R-S90SE12P	

Cabeçotes de Fresar 75°



Diâmetros de corte (mm)	Referências ISO	Pastilhas
050	050A03R-C75SP12C	SPKN 1203
063	063A04R-C75SP12C	
080	080A05R-C75SP12C	
100	100B06R-C75SP12C	



Diâmetros de corte (mm)	Referências ISO	Pastilhas
080	080A06R-F75SP12C	SPKN 1203
100	100B08R-F75SP12C	
125	125B08R F75SP12C	
160	160C10R F75SP12C	
200	200C12R F75SP12C	SPKN 1504
250	250C16R F75SP12C	
315	315C20R F75SP12C	
400	400C26R F75SP12C	
500	500C34R F75SP12C	

*Com calços



Diâmetros de corte (mm)	Referências ISO	Pastilhas
080	080A05R-F75SN12C	SNKN 1204
100	100B06R-F75SN12C	
125	125B08R-F75SN12C	SNMG 1204
160	160C10R-F75SN12C	
200	200C12R-F75SN12C	
250	250C16R-F75SN12C	SNMG 1904
315	315C20R-F75SN12C	
400	400C26R-F75SN12C	
500	500C34R-F75SN12C	

*Negativos

Cabeçotes de Fresar 45°



Diâmetros de corte (mm)	Referências ISO	Pastilhas
040	040A03R-C45SE12C	SEKN 1203
050	050A04R-C45SE12C	
063	063A05R-C45SE12C	SEKN 1504
080	080A06R-C45SE12C	
100	100B06R-C45SE12C	SEMN 1204
125	125B07R-C45SE12C	
160	160C07R-C45SE12C	
200	200C08R-C45SE12C	
250	250C10R-C45SE12C	
315	315C12R-C45SE12C	
400	400C14R-C45SE12C	

*Pastilhas redondas para cima



Diâmetros de corte (mm)	Referências ISO	Pastilhas
100	100B06R-F45SE12C	SEKN 1203
125	125B08R F45SE12C	
160	160C10R F45SE12C	SEKN 1504
200	200C12R F45SE12C	
250	250C16R F45SE12C	SEMN 1204
315	315C20R F45SE12C	
400	400C24R F45SE12C	
500	500C32R F45SE12C	

*Com calços



Diâmetros de corte (mm)	Referências ISO	Pastilhas
040	040A04R-SMORC12C	RCMT 1204MO
050	050A05R-SMORC12C	
063	063A05R-SMORC12C	
080	080A06R-SMORC12C	

*Para faceamento

Fresas de Topo



Diâmetros de corte (mm)	Referências ISO	Pastilhas
12	12A1R025A12-CTP11	TPGN 1102
14	14A1R025A14-CTP11	
16	16A1R025A16-CTP11	
18	18A1R025A18-CTP11	
20	20A2R030A20-CTP11	
25	25A2R030A20-CTP11	
25	25A2R030A25-CTP11	TPKN1603
32	32A2R035A20-CTP16	
32	32A2R035A32-CTP16	
40	40A3R035A20-CTP16	
40	40A3R035A32-CTP16	

*Haste cilíndrica



Diâmetros de corte (mm)	Referências ISO	Pastilhas
12	12A1R025D16-CTP11	TPGN 1102
14	14A1R025D16-CTP11	
16	16A1R025D16-CTP11	
18	18A1R025D16-CTP11	
20	20A2R030D20-CTP11	
25	25A2R030D20-CTP11	
25	25A2R030D25-CTP11	
32	32A2R035D25-CTP16	TPKN 1603
32	32A2R035D32-CTP16	
40	40A3R035D32-CTP16	

*Haste cilíndrica com chato (weldon)



Diâmetros de corte (mm)	Referências ISO	Pastilhas
12	12A1R025E03-CTP11	TPGN 1102
14	14A1R025E03-CTP11	
16	16A1R025E03-CTP11	
18	18A1R025E03-CTP11	
20	20A2R030E03-CTP11	
25	25A2R030E03-CTP11	
32	32A2R035E03-CTP16	TPKN 1603
40	40A3R035E03-CTP16	

*Cone Morse 3 com rosca



Diâmetros de corte (mm)	Referências ISO	Pastilhas
12	12A1R016A16-SMP10	APLX 1003
16	16A2R020A16-SMP10	
20	20A3R025A20-SMP10	
25	25A3R032A25-SMP10	
25	25A2R032A25-SMP16	APKT 1604
32	32A3R040A32-SMP16	
40	40A4R050A32-SMP16	

*Haste cilíndrica



Diâmetros de corte (mm)	Referências ISO	Pastilhas
12	12A1R016B16-SMP10	APLX 1003
16	16A2R020B16-SMP10	
20	20A3R025B20-SMP10	
25	25A3R032B25-SMP10	
25	25A2R032B25-SMP16	APKT 1604
32	32A3R040B32-SMP16	
40	40A4R050B32-SMP16	

*Haste cilíndrica com chato (weldon)



Diâmetros de corte (mm)	Referências ISO	Pastilhas
12	12A1R021E02-SMP10	APLX 1003
16	16A2R025E02-SMP10	
20	20A3R030E03-SMP10	
25	25A3R037E03-SMP10	
25	25A2R040E03-SMP16	APKT 1604
32	32A3R048E03-SMP16	
40	40A4R059E04-SMP16	

*Cone Morse

Fresas de mergulho



Diâmetros de corte (mm)	Referências ISO	Pastilhas
12	12M1R020A16-SMP10	APLX 1003
16	16M1R025A16-SMP10	
20	20M1R039A20-SMP16	APKT 1604
25	25M2R039A25-SXX16	
32	32M2R039A32-SXX16	
40	40M2R039A32-SXX16	

*Haste cilíndrica



Diâmetros de corte (mm)	Referências ISO	Pastilhas
12	12M1R020D16-SMP10	APLX 1003
16	16M1R025D16-SMP10	
20	20M1R039D20-SMP16	APKT 1604
25	25M2R039D25-SXX16	
32	32M2R039D32-SXX16	
40	40M2R039D32-SXX16	

*Haste cilíndrica com chato (weldon)



Diâmetros de corte (mm)	Referências ISO	Pastilhas
12	12M1R020E02-SMP10	APLX 1003
16	16M1R025E02-SMP10	
20	20M1R039E03-SMP16	APKT 1604
25	25M2R039E03-SXX16	
32	32M2R039E03-SXX16	
40	40M2R039E03-SXX16	
40	40M2R039E04-SXX16	

*Cone Morse

Fresas para arredondar

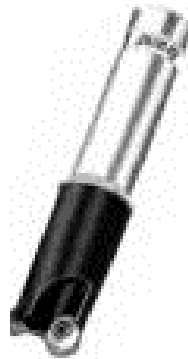

Diâmetros de corte (mm)	Referências ISO	Pastilhas
16	16E2R30A20-SRC10	RCMT 10T3
20	20E2R35A25-SRC12	APKT 1604
25	25E3R35A32-SRC12	
32	32E3R50A32-SRC12	
40	40E3R50A32-SRC12	

*Haste cilíndrica



Diâmetros de corte (mm)	Referências ISO	Pastilhas
16	16E2R50D20-SRC10	RCMT 10T3
20	20E2R60D25-SRC12	
25	25E3R75D32-SRC12	
32	32E3R100D32-SRC12	
40	40E3R100D32-SRC12	

*Haste com chato (weldon)



Diâmetros de corte (mm)	Referências ISO	Pastilhas
16	16E2R50E02-SRC10	RCMT 1204
20	20E2R60E03-SRC12	
25	25E3R75E03-SRC12	
32	32E3R100E04-SRC12	
40	40E3R100E04-SRC12	

*Cone Morse

Fresas para copiar



Diâmetros de corte (mm)	Referências ISO	Pastilhas
10	10K1R20A16-SXP07	R216.24-0702050-AA
12	12K1R25A16-SXD08	R216.24-0802060-AA
16	16K1R32A16-SXD10	R216.24-1003080-AA
20	20K1R40A20-SXD13	R216.24-13T3100-AB
25	25K1R50A25-SXD16	R216.24-1504125-AB
32	32K1R65A32-SXP19	R216.24-1704160-AB

*Haste cilíndrica



Diâmetros de corte (mm)	Referências ISO	Pastilhas
10	10K1R50D16-SXP07	R216.24-0702050-AA
12	12K1R50D16-SXD08	R216.24-0802060-AA
16	16K1R63D20-SXD10	R216.24-1003080-AA
20	20K1R80D25-SXD13	R216.24-13T3100-AB
25	25K1R100D25-SXD16	R216.24-1504125-AB
32	32K1R125D32-SXP19	R216.24-1704160-AB

*Haste cilíndrica com rosca e chato (weldon)

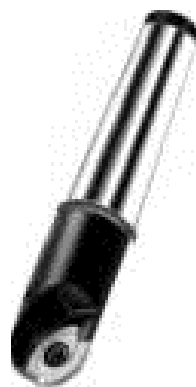

Diâmetros de corte (mm)	Referências ISO	Pastilhas
10	10K1R50E02-SXP07	R216.24-0702050-AA
12	12K1R50E02-SXD08	R216.24-0802060-AA
16	16K1R63E02-SXD10	R216.24-1003080-AA
20	20K1R80E02-SXD13	R216.24-13T3100-AB
25	25K1R100E03-SXD16	R216.24-1504125-AB
32	32K1R125E02-SXP19	R216.24-1704160-AB

*Cone Morse

Fresas Abacaxi



Diâmetros de corte (mm)	Larguras de corte (mm)	Referências ISO
50	37	050A04R-S90XP15P37
50	44	050A04R-S90XP15P44
50	51	050A04R-S90XP15P51
63	44	063A06R-S90XP15P44
63	51	063A06R-S90XP15P51
63	59	063A06R-S90XP15P59
80	59	080A06R-S90XP15P59
80	66	080A06R-S90XP15P66
80	73	080A06R-S90XP15P73
100	73	100A08R-S90XP15P73
100	80	100A08R-S90XP15P80
100	87	100A08R-S90XP15P87

*Cabeçotes de desbaste lateral

Fresas de desbaste lateral



Diâmetros de corte (mm)	Larguras de corte (mm)	Referências ISO
40	37	40J4R82G50-SXP37
40	44	40J4R89G50-SXP44
40	51	40J4R96G50-SXP51
40	59	40J4R104G50-SXP59
50	59	50J4R104G50-SXP59
50	66	50J4R111G50-SXP66
50	73	50J4R118G50-SXP73
63	73	63J6R118G50-SXP73
63	80	63J6R125G50-SXP80
80	73	80J6R118G50-SXP73
80	80	80J6R125G50-SXP80
80	87	80J6R132G50-SXP87
80	95	80J6R140G50-SXP95
80	103	80J6R148G50-SXP103
80	110	80J6R155G50-SXP110
100	95	100J8R140G50-SXP95
100	103	100J8R140G50-SXP103
100	110	100J8R140G50-SXP110
100	117	100J8R140G50-SXP117

*Cone ISO 50 DIN 2080



Diâmetros de corte (mm)	Larguras de corte (mm)	Referências ISO
40	37	40J04R82H50-SXP37
40	44	40J04R89H50-SXP44
40	51	40J04R96H50-SXP51
40	59	40J04R104H50-SXP59
50	59	50J04R104H50-SXP59
50	66	50J04R111H50-SXP66
50	73	50J04R118H50-SXP73
63	73	63J06R118H50-SXP73
63	80	63J06R125H50-SXP80
80	73	80J06R118H50-SXP73
80	80	80J06R125H50-SXP80
80	87	80J06R132H50-SXP87
80	95	80J06R140H50-SXP95
80	103	80J06R148H50-SXP103
80	110	80J06R155H50-SXP110
100	95	100J08R140H50-SXP95
100	103	100J08R148H50-SXP103
100	110	100J08R155H50-SXP110
100	117	100J08R162H50-SXP117

*Cone ISO 50 DIN 69871

Cabeçotes de desbaste lateral



Diâmetros de corte (mm)	Larguras de corte (mm)	Referências ISO
125	80	125B08R-F90TP22P80
125	92	125B08R-F90TP22P92
125	105	125B08R-F90TP22P105
125	117	125B08R-F90TP22P117

*Com porta insertos

Fresas de desbaste lateral



Diâmetros de corte (mm)	Larguras de corte (mm)	Referências ISO
80	80	80J6R111G50-FTP80
80	92	80J6R111G50-FTP92
80	105	80J6R111G50-FTP105

*Com porta insertos cone ISO 50 DIN 2080



Diâmetros de corte (mm)	Larguras de corte (mm)	Referências ISO
80	80	80J6R111H50-FTP80
80	92	80J6R111H50-FTP92
80	105	80J6R111H50-FTP105

*Com porta insertos ISO 50 DIN 69871



Diâmetros de corte (mm)	Larguras de corte (mm)	Referências ISO
25	17	25J4R58G30-SMP17
25	25	25J4R66G30-SMP25
32	25	32J4R66G30-SMP25
32	32	32J4R73G30-SMP32
32	40	32J4R81G30-SMP40
32	48	32J4R89G30-SMP48

*Cone ISO 30 DIN 2080



Diâmetros de corte (mm)	Larguras de corte (mm)	Referências ISO
25	17	25J4R58H30-SMP17
25	25	25J4R66H30-SMP25
32	25	32J4R66H30-SMP25
32	32	32J4R73H30-SMP32
32	40	32J4R81H30-SMP40
32	48	32J4R89H30-SMP48

*Cone ISO 30 DIN 69871



Diâmetros de corte (mm)	Larguras de corte (mm)	Referências ISO
25	17	25J4R58H40-SMP17
25	25	25J4R66H40-SMP25
32	25	32J4R66H40-SMP25
32	32	32J4R73H40-SMP32
32	40	32J4R81H40-SMP40
32	48	32J4R89H40-SMP48
40	37	40J4R78H40-SXP37
40	44	40J4R85H40-SXP44
40	51	40J4R92H40-SXP51
40	59	40J4R100H40-SXP59
50	44	50J4R85H40-SXP44
50	66	50J4R107H40-SXP66

*Cone ISO 40 DIN 69871



Diâmetros de corte (mm)	Larguras de corte (mm)	Referências ISO
25	17	25J4R58G30-SMP17
25	25	25J4R66G30-SMP25
32	25	32J4R66G30-SMP25
32	32	32J4R73G30-SMP32
32	40	32J4R81G30-SMP40
32	48	32J4R81G30-SMP40

*Cone ISO 40 DIN 2080



Diâmetros de corte (mm)	Larguras de corte (mm)	Referências ISO
25	17	25J4R32A25-SMP09
25	25	25J4R40A25-SMP09
32	25	32J4R40A32-SMP09
32	32	32J4R50A32-SMP09
32	48	32J4R61A32-SMP09

*Haste cilíndrica



Diâmetros de corte (mm)	Larguras de corte (mm)	Referências ISO
25	17	25J4R32D25-.SMP17
25	25	25J4R40D25-SMP25
32	25	32J4R40D32-SMP25
32	32	32J4R45D32-SMP32
32	40	32J4R53D32-SMP40
32	48	32J4R61D32-SMP48
40	37	40J4R50D32-SXP37
40	44	40J4R57D32-SXP44
40	51	40J4R64D32-SXP51
40	59	40J4R72D32-SXP59

*Haste cilíndrica com rosca e chato (weldon)



Diâmetros de corte (mm)	Larguras de corte (mm)	Referências ISO
25	17	25J4R37E03-SMP17
25	25	25J4R48E03-SMP25
32	25	32J4R48E03-SMP25
32	32	32J4R58E03-SMP32
32	40	32J4R59E04-SMP40
32	48	32J4R67E04-SMP48
40	37	40J4R59E04-SXP37
40	44	40J4R66E04-SXP44
40	51	40J4R73E04-SXP51
40	59	40J4R81E04-SXP59

*Cone Morse



Diâmetros de corte (mm)	Larguras de corte (mm)	Referências ISO
25	17	25J4R51X50-SMP17
25	25	25J4R65X50-SMP25
32	25	32J4R65X50-SMP25
32	32	32J4R65X50-SMP32
32	40	32J4R81X50-SMP40
32	48	32J4R92X63-SMP48
40	37	40J4R61X50-SXP37
40	44	40J4R68X50-SXP44
40	51	40J4R77X63-SXP51
40	59	40J4R85X63-SXP59
50	44	50J4R68X50-SXP59
50	60	50J4R93X63-SXP59

*Sistema varilock

Fresas de Disco



Diâmetros de corte (mm)	Larguras de Corte (mm)	Referências ISO	Pastilhas
80	12	080F06N.F90TP11P12	TPAN 1103
80	14	080F06N.F90TP11P14	
100	12	100G08N.F90TP11P12	
100	14	100G08N.F90TP11P14	
125	12	125H10N.F90TP11P12	
125	14	125H10N.F90TP11P14	
160	12	160H12N.F90TP11P12	
160	14	160H12N.F90TP11P14	
125	16	125H08N.F90TP16P16	TPAN 1603
125	18	125H08N.F90TP16P18	
125	20	125H08N.F90TP16P20	
125	22	125H08N.F90TP16P22	
160	16	160H10N.F90TP16P16	
160	18	160H10N.F90TP16P18	
160	20	160H10N.F90TP16P20	
160	22	160H10N.F90TP16P22	
200	20	200J12N.F90TP16P20	
200	22	200J12N.F90TP16P22	
200	24	200J12N.F90TP16P24	
250	20	250J16N.F90TP16P20	
250	22	250J16N.F90TP16P22	
250	24	250J16N.F90TP16P24	
315	24	315J20N.F90TP16P24	
315	25	315J20N.F90TP16P25	
315	26	315J20N.F90TP16P26	

*03 cortes



Diâmetros de corte (mm)	Referências ISO	Pastilhas
100	100G06R.F90TP16P	TPKN 1603EDR
125	125H08R.F90TP16P	
160	160H10R.F90TP16P	
200	200J12R.F90TP16P	
250	250J16R.F90TP16P	
315	315J20R.F90TP16P	

*02 cortes direita



Diâmetros de corte (mm)	Referências ISO	Pastilhas
100	100G06L.F90TP16P	TPKN 1603EDL
125	125H08L.F90TP16P	
160	160H10L.F90TP16P	
200	200J12RLF90TP16P	
250	250J16R.L90TP16P	
315	315J20R.L90TP16P	

*02 cortes esquerda



Diâmetros de corte (mm)	Larguras de Corte (mm)	Referências ISO	Pastilhas
80	5	080F08NS90SN12B05	331.31.3012
100	5	100G10NS90SN12B05	331.31.3012
100	6	100G10NS90SN12B06	331.31-3512
125	5	125H12NS90SN12B05	331.31-3012
125	5	125H12NS90SN12B06	331.31-3512
125	6	125H12NS90SN12B08	331.31-4512
160	8	160H16NS90SN12B05	331.31-3012
160	5	160H16NS90SN12B06	331.31-3512
160	6	160H16NS90SN12B08	331.31-4512
200	8	200J20NS90SN12B06	331.31-3512
200	6	200J20NS90SN12B08	331.31-4512
200	10	200J20NS90SN12B10	331.31-6512
250	6	250J24NS90SN12B06	331.31-3512
250	8	250J24NS90SN12B08	331.31-4512
250	10	250J24NS90SN12B10	331.31-6512

*Para ranhurar 5-10 mm

Outros Modelos de Fresas



Diâmetros de corte (mm)	Referências ISO	Pastilhas
80	080A05R-C65CN12C	CNMG 1204
100	100B06R-C65CN12C	
125	125B07R-C65CN12C	
160	160C07R-C65CN12C	CNMG 1906
200	200C08R-C65CN12C	
250	250C10R-C65CN12C	

*Fresas para reutilização de pastilhas CNMG



Diâmetros de corte (mm)	Larguras de corte (mm)	Referências ISO	Pastilhas
21	9	21F2R028A12-SCC09	CCMT0602
25	11	25F4R034A16-SCC11	
32	14	32F4R042A16-SCC14	CCMT0903
40	17	40F4R052A25-SCC17	
50	21	50F4R064A32-SCC21	CCMT1203

*Fresas para rasgo "T"



Diâmetros de corte(mm)	Larguras de corte(mm)	Referências ISO	Pastilhas	
38	8	38Y1R20A16-SDC08	2 X DCMT11T304	
63	22	63Y1R30A25-XXX22	1 X DCMT11T304	2 X TPGN16034
104	35	104A02R-X120XXX35C	2 X DCMT11T304	6 X TPGN16034

*Rabo de andorinha



Diâmetros de corte (mm)	Ângulo (°)	Referências ISO	Pastilhas
9	45	09D1R32A16-SSP09	SPMX0602
12	45	12D1R37A20-SSP1	SPMT120408
16	45	16D2R35A20-SSP09	SPMT0903
20	45	20D2R35A20-SSP09	SPMT0903
25	45	25D2R40A32-SSP12	SPMX12T3AP
32	45	32D3R46A32-SSP12	SPMT120408
12	60	12C1R37A20-SSP12	SPMT120408
20	60	20C2R35A20-SSP09	SPMT0903
36	60	36C3R36A32-SSP12	SPMT120408
32	45	32D3R30A32-CTP16	TPGN160308

*Fresas para chanfrar